



# *TRUE BALLISTIC*

## QUICK START

To use the chronograph, follow these steps:

- Remove the chronograph from the table stand and connect it to a tripod or the table stand.
- Place the chronograph next to the gun and aim it at the target you plan to shoot.
- Press the power button for a second to turn on the chronograph.
- Once the chronograph has started up, press the power button again to activate it.
- Shoot.

# MANUAL

## 1. SETUP

During transport, the chronograph can be placed inside the table stand. To set up the chronograph, first push it out of the table stand from the tabs located on the sides of the unit. Then, connect the chronograph to the stand, or alternatively, use a tripod.

**The power button** for the chronograph is located below the display of the device. Next to the power button, you will find a USB-C charging port and charging LEDs.

**To turn on the chronograph, press the power button for a second.** To turn it off, press and hold the power button. The chronograph will automatically shut down after a period of inactivity to save power. **To activate the chronograph, press the power button** after the initial boot sequence.

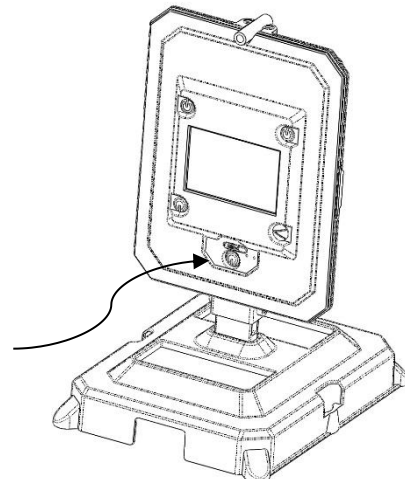
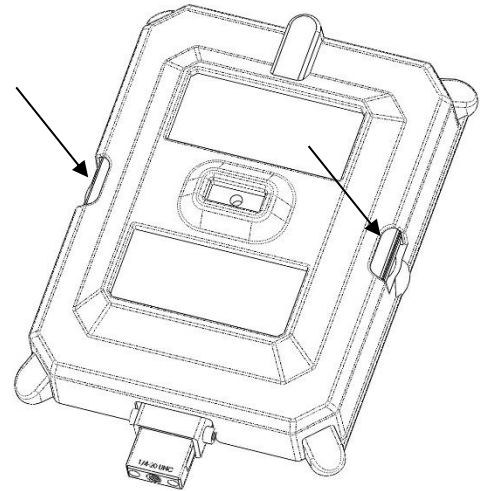

## 2. BATTERY AND CHARGING

The chronograph has a lithium-ion battery that should be charged before using it for the first time. Use the supplied USB-A to USB-C cable to charge the battery. While the battery is charging, the LED lights on the side of the USB port will show the charging progress. A solid red light (only) means that the battery is almost empty, while a solid green light indicates that charging is complete. A flashing green light means that the battery level is more than 75%

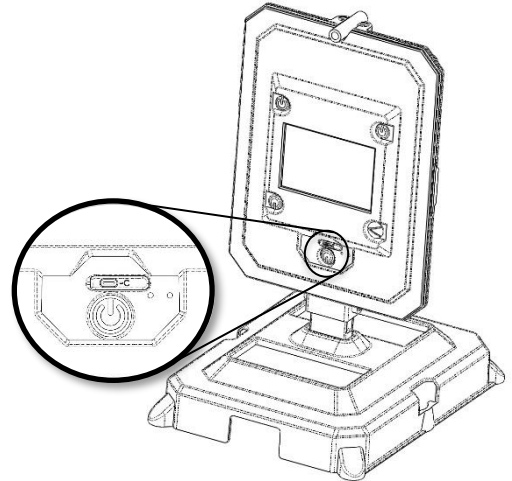

- If the device will not be used for an extended period of time, **it is recommended to store the device with a charge between 50-75%.**
- **Avoid fully discharging the battery**, as this can shorten its overall lifespan.
- If the battery has not been used for a long period of time, it may need to be charged and discharged a few times to reach its full capacity.
- Avoid charging the device in extreme temperatures, as this can also damage the battery.
- Avoid storing the device in a place with extreme temperatures, as this can also damage the battery.

It is generally recommended to store lithium-ion batteries at a temperature between 15°C (59°F) and 25°C (77°F). Storing the battery at a temperature outside of this range can damage the battery and shorten its lifespan.

It is also important to avoid exposing the battery to extreme temperatures, both high and low, during use. For example, do not leave the device in a hot car or in direct sunlight for an extended period of time, as this can cause the battery to overheat and become damaged. Similarly, do not use the device in extremely cold temperatures, as this can also damage the battery.

### 3. POSITIONING THE CHRONOGRAPH

**The best placement for the chronograph is behind the muzzle and close to the barrel** on either side of the gun. The barrel of the gun should be positioned vertically between the top and bottom of the device, with the middle being the optimal placement.

The performance of the chronograph improves when it is positioned close to the barrel because this reduces the cosine error, which can affect the accuracy of the readings. Cosine error is a type of error that can arise when measuring the velocity of projectiles with radar technology, and it is caused by the angle at which the radar beam hits the projectile. By positioning the chronograph close to the barrel, you can reduce the cosine error and improve the accuracy of the readings.

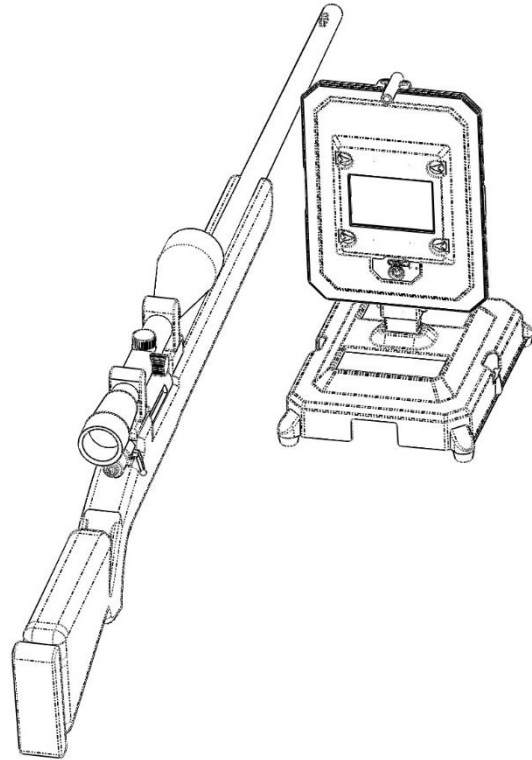

If the chronograph needs to be positioned away from the barrel, make sure to set the correct Barrel Offset in the configuration menu. The default setting for Barrel Offset is 0"-8". This ensures that the chronograph accurately measures the bullet's velocity.

**It is important not to place other devices, such as other velocity chronographs, in front of the radar when using the chronograph.** This can interfere with the accuracy of the readings.

## ALTERNATIVE POSITIONS FOR THE CHRONOGRAPH (TOP VIEW)

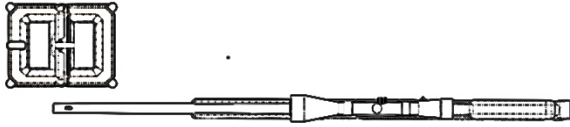

Positioning the chronograph next to the muzzle, or in front of it, is **only possible when the gun has a very light muzzle blast**. The intense pressure and heat generated by the gun when it is fired can damage the chronograph if it is positioned too close to the muzzle. Therefore, it is important to position the chronograph carefully to avoid damage and ensure accurate measurements. If the gun has a strong muzzle blast, it is necessary to position the chronograph further away from the muzzle.

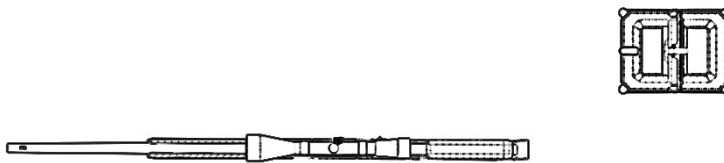

While it is possible to position the chronograph behind the shooter, keep in mind that the shooter may block the field of view to the muzzle. If this occurs, the chronograph will not trigger at the muzzle and the recorded velocity will be in front of the muzzle. To avoid this issue, **position the chronograph so that it has a clear view of the muzzle**. This will ensure that the chronograph triggers at the correct time and provides an accurate measurement of the bullet's velocity.

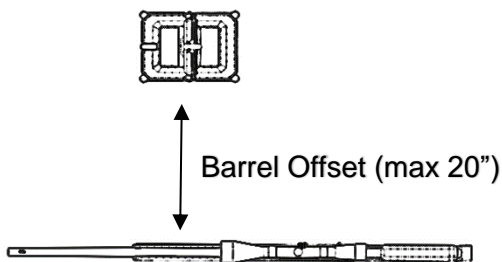

Positioning the chronograph away from the barrel is **not recommended** because it increases the angle between the radar beam and the bullet trajectory. This can cause the chronograph to provide inaccurate measurements of the bullet's velocity. If it is necessary to use this position, make sure to set the correct Barrel Offset in the device's configuration menu. This will help to counteract the effects of cosine error, which can cause the chronograph to provide inaccurate measurements when the angle between the radar beam and bullet trajectory is large.

## SHOOTING WITH HIGH CALIBER OR MUZZLE BRAKE

The muzzle blast from high-caliber firearms or those using a muzzle brake can momentarily obscure the chronograph's view of the bullet. If the chronograph is not triggering as expected, there are several troubleshooting steps to consider.

Firstly, ensure that the chronograph is positioned approximately 4-6 inches (10-15 cm) from the barrel and is well-aligned with the target, providing a clear line of sight.

If the issue persists, you can adjust the trigger sensitivity setting on the chronograph. Here's how: Press the top left button, find the "Trigger Sens" settings, adjust the trigger sensitivity to a more sensitive level, and save the settings.

Another solution is to place a barrier between the chronograph and the firearm. Please ensure this barrier is placed carefully so as not to obstruct the chronograph's view of the target or pose a safety risk.

As a last resort, you could position the chronograph in front of the firearm. However, exercise extreme caution when doing this to avoid inadvertently shooting the chronograph. A distance of at least 3 - 5 feet (1m – 1.5m) in front is a good starting point. If the muzzle blast is large, you may have to move it further away. Be aware that the bullet's trajectory should pass the chronograph no more than 10 inches (25cm) away from the side of the chronograph.

## SHOOTING FROM THE PRONE POSITION

When shooting from the prone position, it's crucial to ensure that the chronograph has a clear line of sight to the target, unobstructed by any obstacles such as tall grass. If necessary, you might need to slightly elevate the chronograph to maintain this clear view. However, when adjusting the height, be mindful not to significantly increase the distance from the barrel to the chronograph. The optimal position strikes a balance between these two factors: it's elevated enough to provide an unobstructed view of the target, yet remains within close proximity to the barrel.

## MULTIPLE CHRONOGRAHS / RADARS

If multiple chronographs are operating in close proximity, it is necessary to adjust the channel settings of each to prevent any potential interference.

- Access the configuration menu by clicking the top left button.
- Look for the interference indicator and enable it.
- Save these settings.
- Activate the chronograph and check the interference indicator. If it's showing an acceptable level, there's no need for further adjustment. However, if another chronograph is operating on the same channel or frequency, the indicator will reach its maximum.
- If the indicator shows high interference, return to the configuration menu and change your channel. Once the change is made, activate the chronograph again and see if the interference has reduced to an acceptable level.

The channel setting allows you to choose from 12 different channels.

### **OTHER SHOOTERS**

If another shooter's activity is causing your chronograph to trigger, this can be mitigated by lowering your trigger sensitivity. To adjust this, press the button on the top left to access the configuration settings and look for the trigger sensitivity option. Reduce the sensitivity and check if the problem persists.

## 4. ALIGNING AND TRIGGERING

To use the chronograph, **first aim the sight on top of it at the target.**

The triangle shape on the top view of the chronograph represents the **radar cone**, with the middle part indicating the strongest signal and the side parts indicating weaker signals. A radar cone is a term used to describe the shape and direction of a radar beam. When a radar signal is transmitted, it spreads out in a cone shape, with the narrowest part of the cone at the point where the signal is emitted. As the signal travels farther from the source, the cone widens. The radar cone is important because it determines the area that the radar can detect and the direction in which it can detect objects. Because the strong signal emitted by the chronograph is very narrow, it is important to **aim the device carefully** for accurate results. The weak signal is also important, as it is used for **triggering the chronograph**. When the bullet enters the radar cone (indicated by the weak signal), the chronograph is triggered.

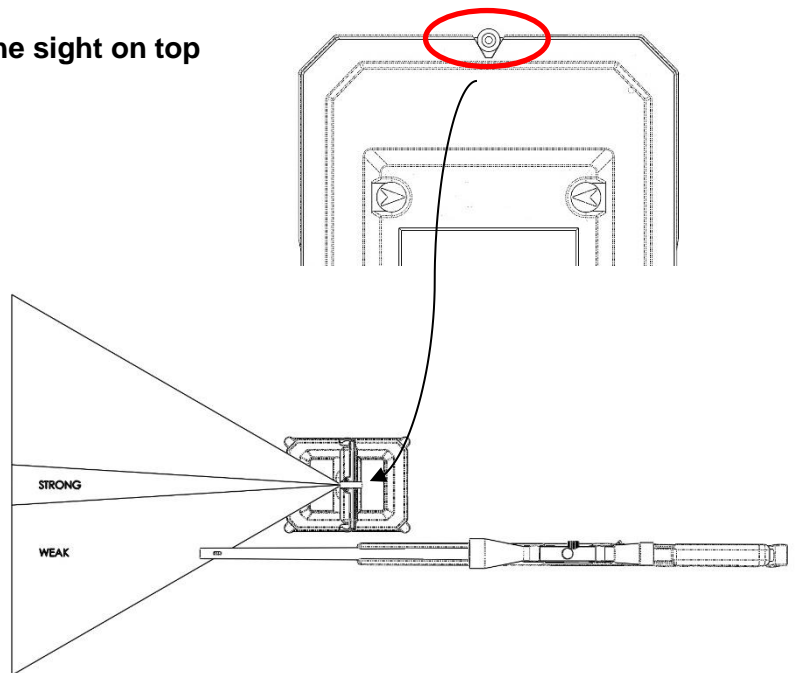

If the chronograph is not positioned with a clear line of sight to the muzzle, it will trigger slightly after the bullet exited the muzzle and will not be able to accurately measure the velocity at the muzzle.

For accurate results, **the chronograph should have a clear line of sight to the target**, which should be at least **25 yards away**. The absolute minimum distance is 15 yards. Any obstacles in the line of sight may affect the accuracy of the readings or cause the chronograph to fail to trigger correctly.

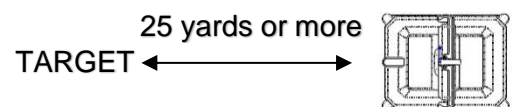

Metal or concrete surfaces in the line of sight may reflect the radar's signal back to the unit, causing the antenna to receive a very strong signal that can hide the reflected signal from the bullet. To avoid this, avoid using metal materials behind the target. Shooting in very narrow ranges, such as indoors, can also affect the radar's ability to track the bullet. **It is not recommended to use a chronograph indoors.**

For more (advanced) information on aiming the chronograph, see the "Interference Indicator" section.



## 5. MAIN SCREEN

To begin measuring velocities with the chronograph, press the power button when the startup screen appears. This will activate the radar and allow you to take measurements.

Once a shot has been taken, the main screen will display the muzzle velocity in large font, along with velocities for predefined ranges. The black boxes in the corners of the screen indicate the functions of the corresponding buttons. For example, the top left button will take you to the settings/configuration menu, while the bottom buttons will cycle through different pages of information.

The second page shows the velocities in two different user-selectable units, and the third page displays statistics for the current shot string. To start a new shot string on the third page, press the button in the top left corner. To delete the last shot, press the button on the top right corner.

### RADAR DEACTIVATION

If the chronograph is moved while the radar is activated, it may trigger erroneously. To deactivate the radar, tap the power button and to activate it, tap the power button again.

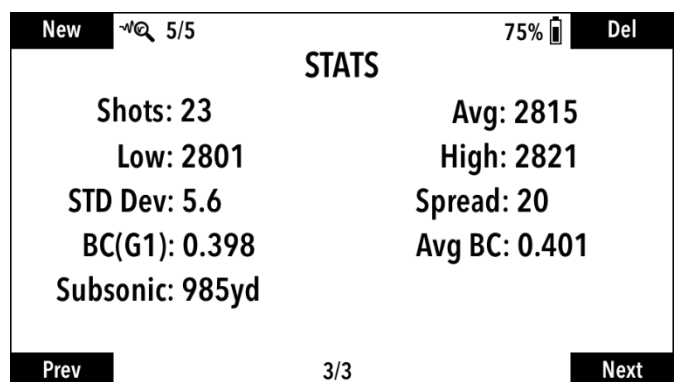
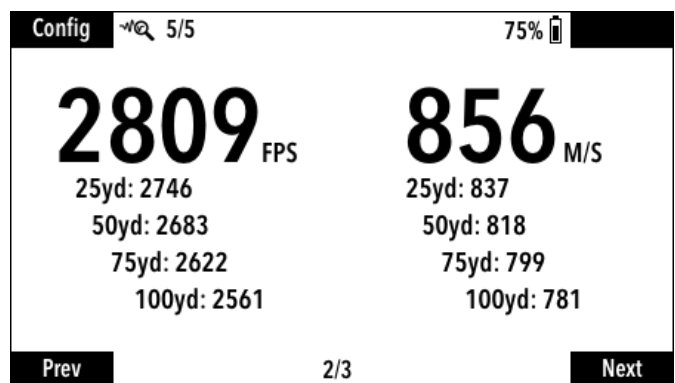
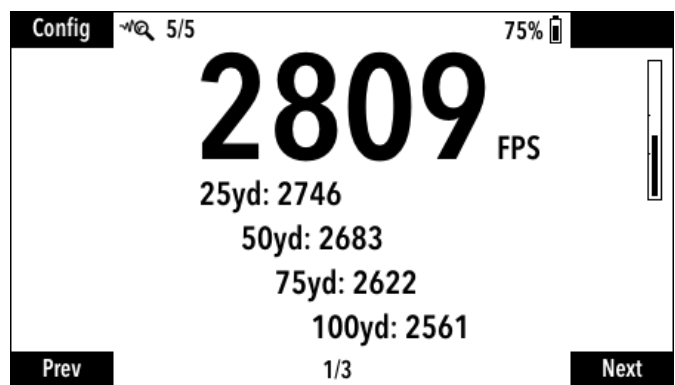

## SIGNAL STRENGTH INDICATOR

Radar signal reflection occurs when a radar signal is transmitted and hits an object, causing some of the signal to be reflected back to the radar receiver. This reflection is used by radar systems to measure speed of objects.

When a radar signal is transmitted, it travels outward in a straight line at the speed of light. When it hits an object, the signal can either be absorbed, transmitted, or reflected. Absorption occurs when the signal is absorbed by the object and converted into heat or other forms of energy. Transmission occurs when the signal passes through the object, such as when it passes through a window or a wall. Reflection occurs when the signal hits the surface of the object and bounces back toward the radar receiver.

The amount of reflection that occurs depends on several factors, such as the size, shape, and composition of the object, as well as the angle at which the signal hits the object. Larger and smoother objects tend to reflect more of the signal, while smaller and rougher objects tend to reflect less. In addition, the angle at which the signal hits the object can affect the amount of reflection. **A signal that hits the object at a steep angle will be more likely to bounce back** toward the radar receiver than a signal that hits the object at a shallow angle.

The “signal strength” for a shot can be seen in the top left corner of the screen. This indicates the strength of the radar signal reflections that the chronograph received from the bullet.

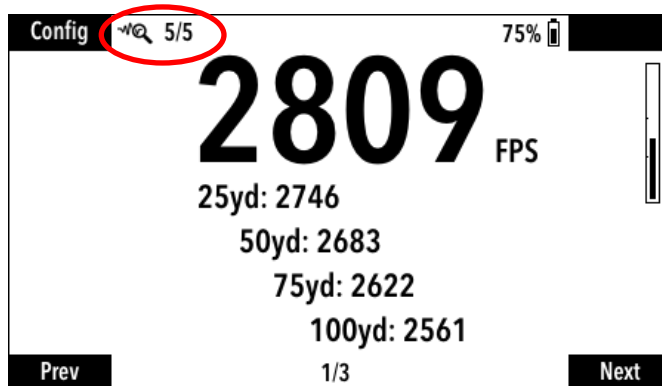

Reading this indicator requires some experience with the chronograph, as the reflected signal can depend on factors such as the positioning and aiming of the chronograph, as well as the type and velocity of the bullet. Generally, small and slow bullets, such as .22 airgun rounds, and fast and large bullets, such as .308 Win rounds, can have a signal strength of 4 out of 5 or 5 out of 5. Small and fast bullets, such as .223 Rem rounds, typically do not have as high of a reading and typically max out at around 3 out of 5. This indicator is useful when you know what to expect. **If the signal strength is much lower than normal, you should check that the chronograph has not been knocked out of position and is still properly aimed at the target.** You should also check that the interference indicator is showing acceptable levels.

## INTERFERENCE INDICATOR

The interference indicator on the right side of the screen (if enabled in settings) shows the strength of the radar signal reflections received from the surroundings. **Large metal or concrete surfaces may reflect the signal back so strongly that it hides the signal reflected from a bullet.**



The indicator has two small horizontal lines, with the **lower one indicating the optimal level** and the upper one indicating the acceptable level. The interference level is updated constantly in real-time, while the signal strength indicator may only be updated after a shot is fired. If the interference level is too high, try adjusting the aiming of the chronograph by slightly rotating it to the left or right to find a direction with lower interference levels. **It is preferable to slightly misalign the chronograph in order to reduce interference**, rather than perfectly aligning it and experiencing an unacceptable level of interference.

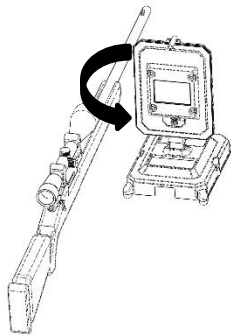

If the chronograph is positioned on the right side of the gun, it is better to **rotate it slightly counterclockwise** to ensure that the transmitted radar signal crosses the bullet's trajectory. Rotating the chronograph clockwise may result in the bullet never entering the strongest area of the radar signal.

## 6. BALLISTICS

In addition to measuring velocities, **the chronograph is capable of calculating bullet trajectories**. To enable this feature, you must choose a **drag model** other than the Basic model in the settings.

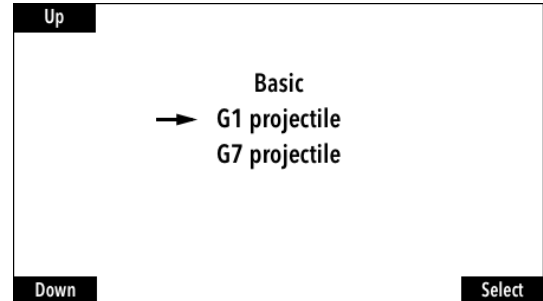

To access the ballistic solution, you must have **Bluetooth enabled** on the chronograph and be connected to it using the FX Radar App.

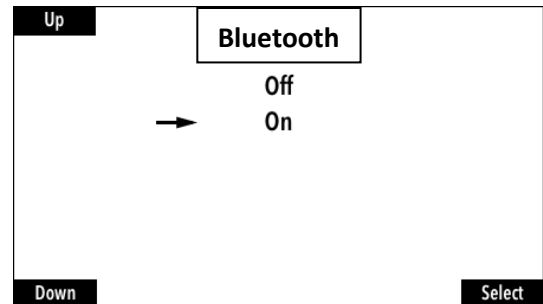

### Drag Models

A drag model is a mathematical representation of the forces that act on a bullet as it travels through the air. These forces include aerodynamic drag, which slows the bullet down, and gravity, which pulls the bullet downward. Drag models are used to predict the trajectory of a bullet and to calculate its velocity, energy, and other characteristics at different distances from the shooter. There are several different drag models that can be used, each with its own assumptions and limitations. The most commonly used drag models for predicting bullet trajectories are the G1, G7.

#### - Basic model

The Basic model is not a real drag model, but it is the quickest to calculate. Use this model if you only need to measure velocities within the radar range and do not need to calculate the bullet's trajectory. **This model is not suitable for calculating bullet trajectories.**

#### - G1 Projectile

**The G1 model is a good starting point if you are unsure which drag model to use.** A G1 projectile is a type of bullet that follows a specific drag model known as the G1 model. The G1 model is a simplified drag model that assumes that the bullet has a uniform,



elongated shape and that it travels through the air at a constant angle. This model is commonly used to predict the trajectory of bullets with a flat- or round-nosed shape, such as those used in hunting rifles. The G1 model is not as accurate as more complex drag models, but it is simple to use and provides reasonable predictions for many applications.

#### **- G7 Projectile**

A G7 projectile is a type of bullet that follows a specific drag model known as the G7 model. G7 refers to the shape of the projectile's cross-sectional density profile, which has been optimized for consistent long-range accuracy (length to diameter ratio of 7). It is characterized by its high ballistic coefficient, which allows it to maintain a stable flight path and resist wind drift over long distances. The G7 projectile is typically made from a boat-tailed bullet design, which helps to reduce drag and improve its overall aerodynamic performance.

#### **- RA4 Projectile**

The RA4 projectile is a bullet that follows a unique drag model known as the RA4 model. This model is specifically designed for heeled bullets, which are commonly used in rimfire rounds such as the .22 Long Rifle. A heeled bullet has a design where the rear part of the bullet is reduced in diameter, known as the "heel", allowing it to fit within the cartridge case. Despite its specificity, the RA4 model is rarely used in comparison to other models. Its main application lies in determining the trajectory of heeled bullets.

#### **(Simple) Ballistic Coefficient – Measured by the chronograph**

A ballistic coefficient (BC) is a measure of how well a bullet maintains its velocity and energy as it travels through the air. A high BC indicates that the bullet is able to maintain its velocity and energy for a longer distance, making it more effective for long-range shooting.

**The chronograph measures the BC value as Simple-BC**, which is weather compensated. This means that there is no need for the user to input weather information to obtain the BC value. However, the BC value only applies to the current weather conditions, and if these conditions change, the chronograph must measure the BC value once more.

#### **Ballistic Solution**

A ballistic solution is a set of calculations that predicts the trajectory of a bullet based on its initial velocity, ballistic coefficient, and the environmental conditions (such as air density, temperature, and wind) at the time of the shot. The ballistic solution is typically used to determine the aiming point for a long-range shot, taking into account the effects of gravity, air resistance, and other factors on the bullet's trajectory.

After selecting the appropriate drag model, the chronograph will calculate the ballistic coefficient (BC) for each shot. Note that the BC calculated by the chronograph may not be directly comparable to the BC provided by the bullet manufacturer, as the user interface for the ballistic calculator in the chronograph has been simplified for ease of use. In most ballistic calculators, user must define a number of variables, such as temperature and air

pressure, that are not required when using the FX True Ballistic Chronograph. **The chronograph is designed to automatically account for the effects of weather on a bullet's trajectory**, and it will include these effects in the calculated BC value. As a result, the reported BC value may vary when conditions change. However, this also means that **the calculated BC and ballistic solution is only valid for the current weather conditions**. If the weather changes, the solution is no longer accurate and a new shot must be taken to generate a new solution.

## Using Ballistic Solution

To access the ballistic solution the chronograph must be connected to the FX Radar App when the shot is taken. **The ballistic solution can be quickly and easily calculated with just two input parameters, which you have to set once for each firearm. The app only needs to know where your scope's zero point is, that's all!** Complete bullet trajectory data is obtained from the chronograph, and the only other required information is the height of the scope. All you need to do is input the scope height and take a few sight-in shots with the chronograph. From these shots, the chronograph will determine the zero point of your scope (= scope angle), making the process simple and efficient. The scope angle is calculated from the user definable sight-in range. For information on where to find the settings, please refer to the FX Radar App manual.

**Scope height** is the vertical distance between the center of the rifle's bore and the center of the scope's reticle. This distance is important because it affects the point of impact of the bullet. If the scope height is too low, the bullet will hit high at short ranges and low at longer ranges. If the scope height is too high, the bullet will hit low at short ranges and high at longer ranges. By accurately measuring the scope height and accounting for it in your ballistic calculations, you can ensure that your shots are accurate at any range.

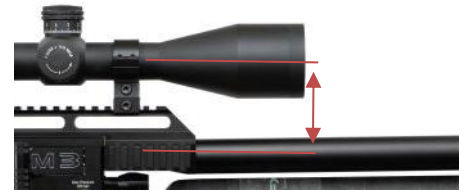

It is important to **calculate the scope angle** for your gun because it allows you to get a correct ballistic solution for any bullet you use. The scope angle is the angle between the scope of a firearm and the barrel of the firearm. Knowing this angle will help you to determine the correct trajectory for any situation, as the **angle does not change unless you adjust your scope's elevation turret**.



In most ballistic calculators, you are required to define a zero range / sight-in range, but this may not be known if the velocity or bullet changes after the gun has been zeroed in. By using the scope angle instead of the sight-in range, you can avoid this problem and get a correct ballistic solution regardless of the bullet's brand or muzzle velocity.

To determine the scope angle, **begin by zeroing your gun** at your desired range. Then, **set the elevation turret to zero**.



Open the ballistic solution in the app and **set the correct sight-in range** in the top left corner of the screen. The ballistic solution can be found on Shot string page of the app.

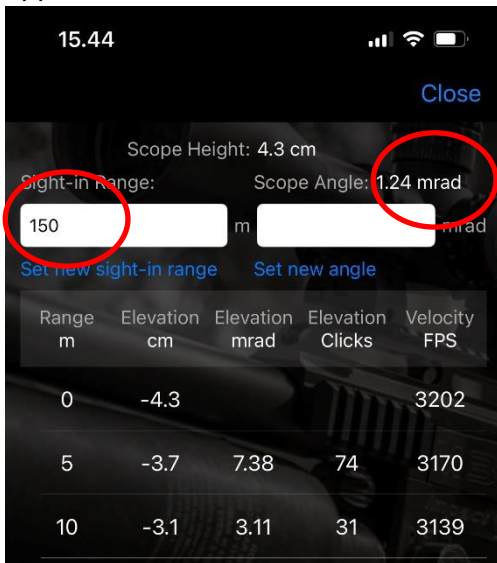

On the top right, you will see the **calculated scope angle** for your current elevation turret position, which in this example is 1.24mrad. You can round this value to 1.2mrad if you want, since it is not possible to adjust the elevation turret in increments of 1/10th of a click. Once you have the calculated scope angle, set it to the scope angle field and use it instead of the sight-in range.

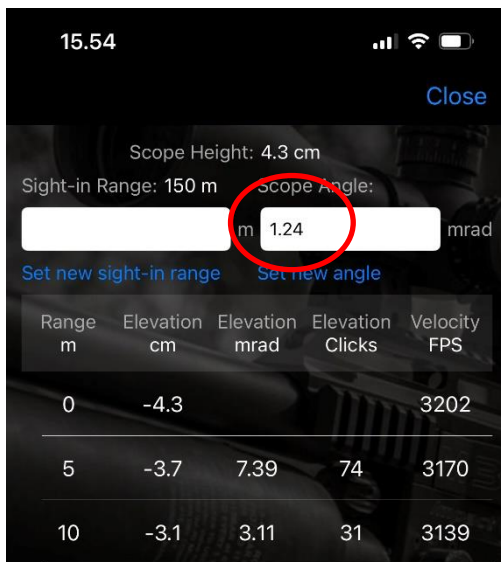

The advantage of using the scope angle instead of the sight-in range is that you can shoot any bullet and get a correct ballistic solution regardless of the actual sight-in range for the bullet. **The elevation clicks reported in the app are based on the elevation turret zero position.** This means that by using the scope angle instead of the sight-in range, you can shoot any bullet and get a correct solution without needing to adjust the sight-in range for each bullet.



For example, imagine taking another shot with the same bullet, but with a slightly higher muzzle velocity. In this case, the ballistic solution would correctly show that the bullet hits 0.6cm (0.2 inches) too high. This difference is minimal but if the bullet was different brand we would see larger difference here.

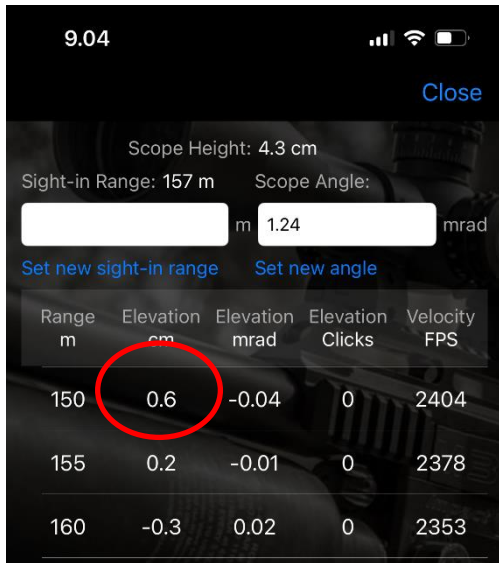

If you need to change your scope angle for any reason, it is easy to do. For example, if you want to set the scope angle of this example to 1.0mrad, which may be easier to remember, you can simply adjust the elevation turret down by two clicks and then reset the turret zero to the new position. In this example, a Mil Dot scope is being used, and one click of the scope equals 0.1mrad. In the case of a MOA scope, one click would equal 0.25 MOA.

Then, you can change the scope angle in the app to 1.0mrad. If you look at the ballistic solution for your new scope angle, you will see that the solution correctly indicates that you would need to make a two-click adjustment up in order to hit your old sight-in range. The new zero elevation distance can be seen on the top left corner of the screen.

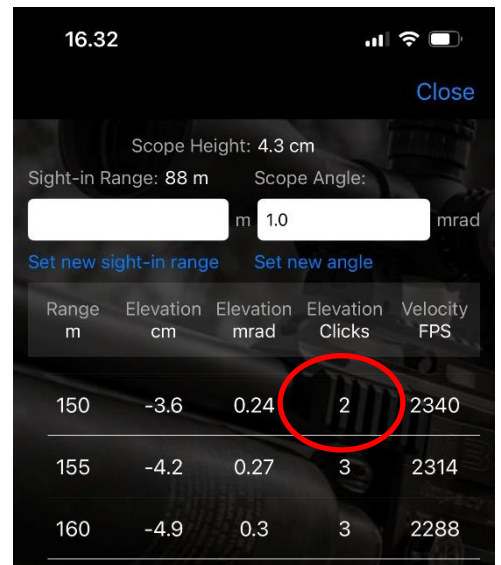

In the above example, the Sako .223 Rem Range was used for shooting. Imagine a situation where you want to shoot at double the initial sight-in range, but this time with a Lapua Scenar OTM bullet instead of the Sako bullet.

The Lapua bullet has a lower muzzle velocity compared to the Sako bullet, but it has a higher ballistic coefficient (BC) value. In this case, the Lapua bullet may not be as fast as the Sako, but its high BC value helps compensate for this and allows it to maintain its accuracy and performance over longer distances.

If you don't have any previous data on the Lapua bullet, you could start by making a copy of the Sako profile and editing the new bullet information (brand and weight) in the copied profile. Then, shoot at least once, but multiple shots would provide a better average. Finally, set your scope angle setting (1.0mrad) and scroll down to the 300 mark.

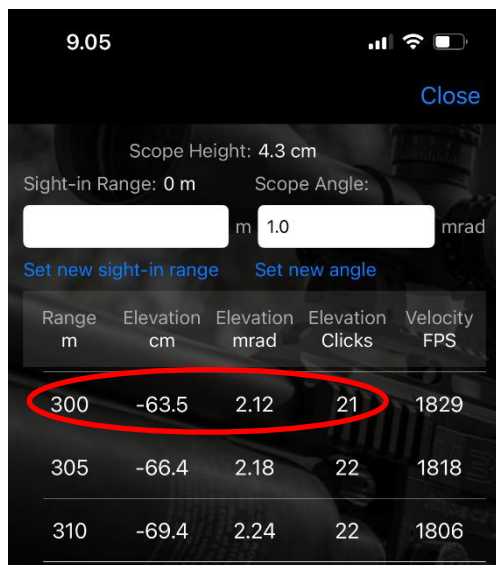

In this situation, you would need to add 21 clicks to your scope to hit the target with the Lapua Scenar OTM bullet.

If you look closely, the app reports a sight-in range of zero for the Lapua bullet. This is because the bullet never reaches the scope line, meaning that it always shoots a little low for every distance.

## 7. SETTINGS

Once the device has finished booting, you will see a screen that allows you to either access the config / settings page or press the power button to activate the chronograph for measuring velocities.

The text "Config" on the top left of the screen indicates that pressing the top left button will access the settings.



After pressing the Config button, you will be taken to a page with the Velocity Range at the top. Since the current firmware only has one velocity range to choose from (400 FPS – 4000 FPS), this option will not be shown.

To navigate through the menu, **use the up and down buttons**. The Settings menu has multiple pages, and to access the next page, simply press down at the last item on the list. To access the primary unit settings, press the button on the bottom left of the screen, then press the button at the **bottom right to select** it. In menus where a numerical value needs to be set, such as projectile weight, you can increase or decrease the setting by pressing the buttons once. **You can also cycle through numbers quickly by holding the button down for an extended period of time.**

**To save the changes you have made, press the button in the top right corner.** If you wish to exit setting without saving, **press and hold the power button** to turn the chronograph OFF

**Primary unit**

The primary unit is the unit of measurement that is primarily used to display the measured velocities.

The primary unit has four different options to choose from. If you choose to use energy units (such as foot-pounds or joules), make sure to verify that the bullet weight is set correctly.

After making your selection, press the select button to confirm it.

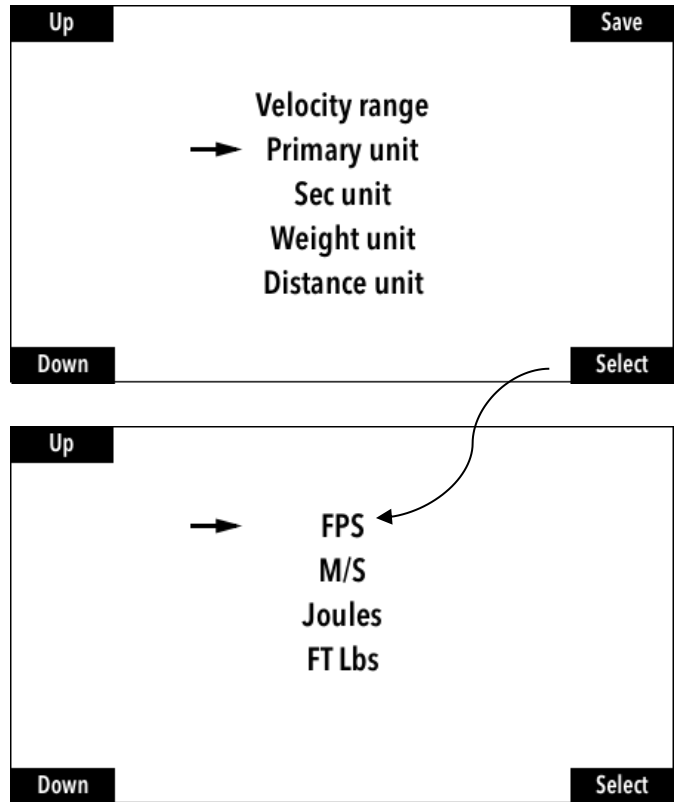

**Secondary unit**

The settings for the secondary unit are the same as for the primary unit. The secondary unit can be seen on page 2 / 3 when measuring velocities together with the primary unit.

**Weight unit**

The weight unit can be set to either grains or grams. This is used when setting the weight of the projectile.

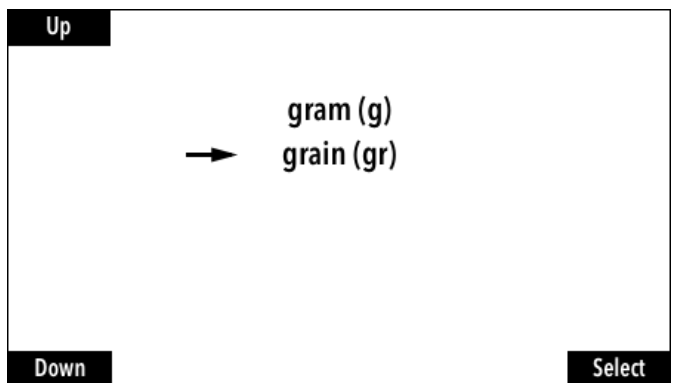

**Distance Unit**

The distance unit is used to display the velocities at different distances. You can choose between meters or yards for the unit of measurement.

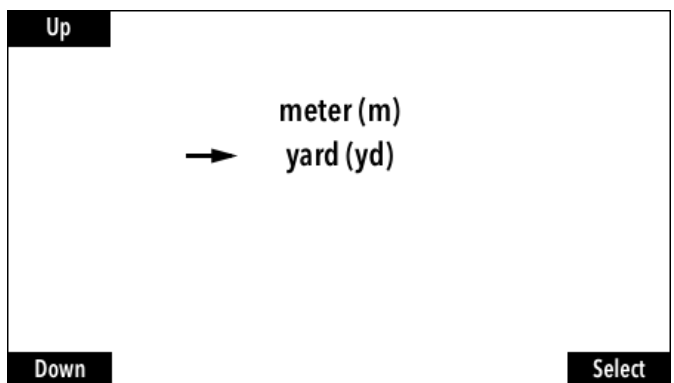

**Distance Dx**

These four settings determine the distances at which the velocity is displayed after each shot in addition to the muzzle velocity. The distances are set using a user-defined distance unit.

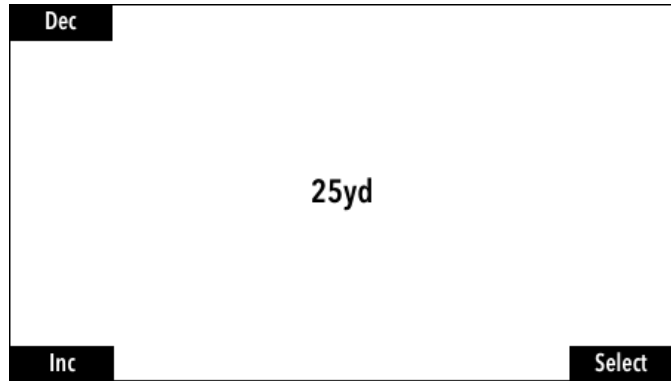

**Projectile weight**

The projectile weight is used to calculate the energy, measured in either foot-pounds or joules. If you are not using energy units, this setting can be disregarded.



**Barrel offset**

Barrel offset is the distance from the side of the unit to the barrel. Placing the chronograph close to the barrel is important for accurate readings.

If the correct value is not set, the readings will be inaccurate. If the setting is too low (indicating that the chronograph is closer to the barrel than it actually is), the velocity reading will be too low, and vice versa.

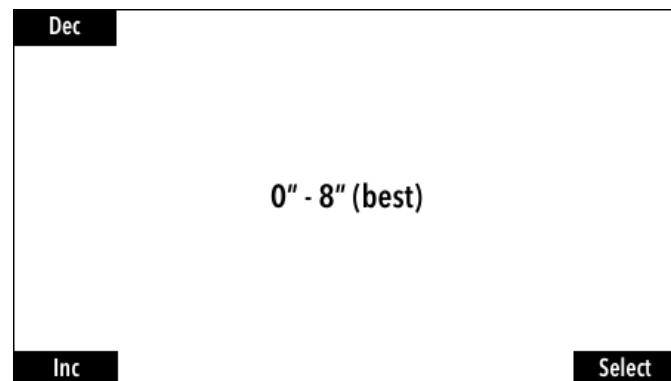

**Channel**

Channel refers to the frequency of operation for the chronograph. If there are multiple chronographs in close proximity, you will need to adjust the channel setting on each one so that they do not interfere with each other. It is recommended to set the channels at least two channels apart from each other to prevent interference. This way, each chronograph will operate at a different frequency and you can avoid any issues with overlapping signals.



**Shutdown time**

Shutdown time refers to the length of time that the device will remain powered on after a period of inactivity, in order to save battery life. This setting allows you to set the amount of time that the device will remain on before shutting off automatically to conserve energy.

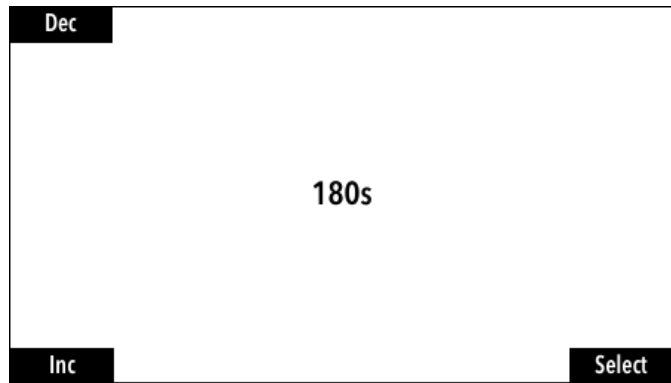

**Drag model**

The basic drag model is the quickest to calculate, but it can only be used when only the velocities within the radar range are required.

The G1, G7 and RA4 models can be used to calculate velocities both inside and outside the radar range, in addition to providing trajectory calculations. The basic drag model, on the other hand, is limited to calculating velocities within the radar range only.

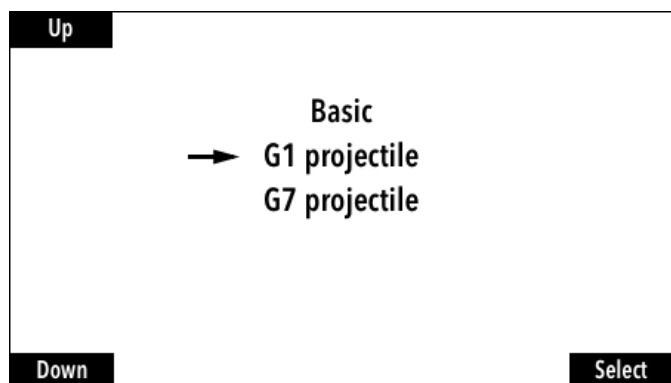

**Interference Indicator**

The interference indicator can be toggled on or off. Please note, it is turned off by default.

**Bluetooth**

This setting allows you to turn Bluetooth on or off. In order to access trajectory information, you must have Bluetooth enabled and be connected to the FX Radar App while taking a shot.

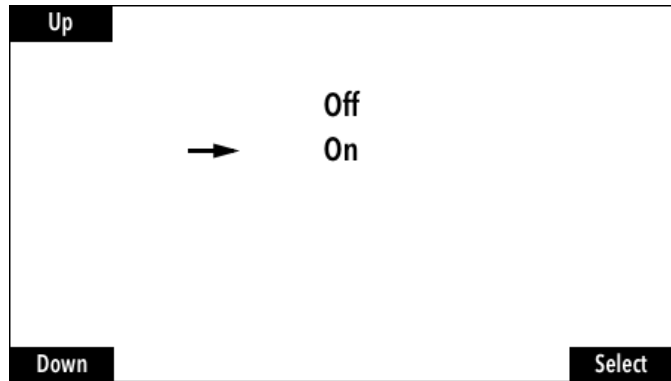

**Trigger Sens**

This setting adjusts the sensitivity level of the chronograph's trigger for measurement. Ideally, it should be sensitive enough to consistently trigger from your gun, yet not so sensitive that it triggers from other shooters, for example.

This setting provides nine sensitivity levels, each with two variants: for example, "Medium" and "Medium (Cross-Verify)". Both versions offer the same sensitivity level, but the "Cross-Verify" variant incorporates additional calculations to avoid erroneous triggering. Generally, the "Cross-Verify" option is most effective, eliminating false triggers entirely. However, in rare instances, it may fail to trigger regardless of the sensitivity level selected. In such circumstances, you might experiment with settings that don't include the cross-verify option.

## Firmware Update: Using Our Firmware Update Website

This manual will guide you through the steps necessary to update the firmware of your FX True Ballistic Chronograph using our firmware update website.

### Prerequisite: Use Google Chrome Browser

Please note that this firmware update process is compatible with Google Chrome browser. If you are using any other browser, please switch to Google Chrome for this process.

### Step 1: Connect to Our Firmware Update Website

Navigate to our firmware update website at the following link:

<https://www.exc.fi/tbc/update/>

### Step 2: Download and Install STM32CubeProgrammer

Your next step is to download and install STM32CubeProgrammer from the link provided below:

<https://www.st.com/en/development-tools/stm32cubeprog.html>

Please note that this software is primarily needed for its driver. You don't need to open or operate this application for the firmware update process.

### Step 3: Connect Your Chronograph to Your Computer

To establish a connection between your chronograph and your computer, use a USB-C cable. It's important to make sure that the USB cable you're using supports data transfer. Some USB cables are designed only for charging, so verify that your cable can transfer data to avoid any issues.

### Step 4: Power Off Your Chronograph

Before we begin the firmware update process, make sure your chronograph is powered off. This is crucial to successfully updating your device's firmware.

### Step 5: Activate Bootloader Mode

With your chronograph powered off, it's time to activate the bootloader mode. To do this, press and hold the top left button (1). While holding this button, press and hold the power button (2). Keep the power button pressed throughout the process. You can release the top left button once bootloader mode is activated.

### Step 6: Connect to Your Device on Our Firmware Update Website

Once you've navigated to our firmware update website, click 'Connect' and select the "STM32 Bootloader" option from the dropdown menu. Click 'Connect' again to establish the connection with your device.

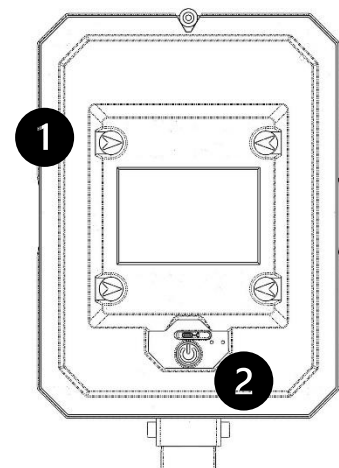

### Step 7: Select and Load the Firmware

In the interface of our firmware update website, select the latest firmware version.

**CE Version:** The CE version of the chronograph complies with the regulations set by the European Union. It is suitable for use within countries that recognize CE certification, which primarily includes countries within the European Economic Area (EEA). When updating the firmware for a CE version device, make sure to select the correct CE version firmware from the options available on our firmware update website.

**FCC Version:** The FCC version of the chronograph complies with the regulations set by the Federal Communications Commission in the United States. It is suitable for use within countries that recognize FCC certification, which primarily includes the United States and its territories. When updating the firmware for an FCC version device, ensure that you select the correct FCC version firmware from the options available on our firmware update website.

### Step 8: Download the Firmware

To perform update, click 'Download'. Make sure to keep the power button pressed throughout this process. This step may take a minute. After the firmware download is complete, your chronograph will be updated with the new firmware.

As always, take your time with each step, especially if this is your first time updating the firmware. Each step is essential to ensuring the successful update of your device.



# FX Radar App

We also provide the FX Radar App, which extends the capabilities of your chronograph, offering additional features such as ballistic calculations and shot string logging.

To start using the FX Radar App, follow these instructions:

- Download the FX Radar App from the respective application store for your device, which will be either the Google Play Store for Android devices or the Apple App Store for iOS devices.
- Make sure the Bluetooth on your device is activated and then launch the FX Radar App.
- Power on your chronograph. Once the app is open, navigate to the home page and click 'connect' when your chronograph appears.

With these steps completed, you're all set to use the FX Radar App to evaluate your shooting data. For a comprehensive understanding of the app and its features, you can access the complete user manual by clicking on the 'manual' link in the 'more' page of the app.

# FX Radar App

Android v1.6.112 or newer, iOS v1.8.67 or newer

## HOME PAGE

1. When the chronograph is not connected, **the home menu** will be black and will show a message indicating that it is waiting for a connection. **Remember to turn on Bluetooth on the chronograph before attempting to connect it to the app.**

Once you tap the "Connect" button, the display will switch to the "Connected" view. This view is divided into three parts.

In rare cases, the app may not be able to find the chronograph. If this happens, try closing the app completely and restarting it. This should fix the problem.

2. The **top section** of the "Connected" view shows the velocity in two different units, with a speaker icon next to each unit to indicate whether the primary or secondary unit is currently selected for voice output. You can turn the voice output on and off by clicking the speaker icon.

The top and middle sections of the "Connected" view can be minimized by clicking the "HIDE" button. This will collapse the sections, allowing you to see more of the bottom section. To expand the sections again, click the "EXPEND" button.

3. The **middle section** of the view displays the velocities of the five most recent shots.
4. The **bottom section** shows the chronograph's battery level and current settings i.e. velocity range.

The **"Disconnect"** button is located below the bottom section of the "Connected" view (it is not visible in the screenshot). When you are finished using the chronograph, you can disconnect the app by clicking this button. The app will also automatically disconnect if the chronograph is turned off.

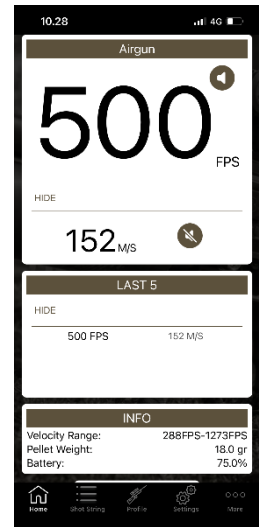
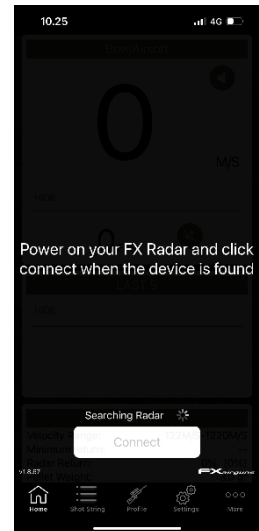

## SHOT STRING PAGE

1. The "Shot String" page shows a summary of all shots in the current string.

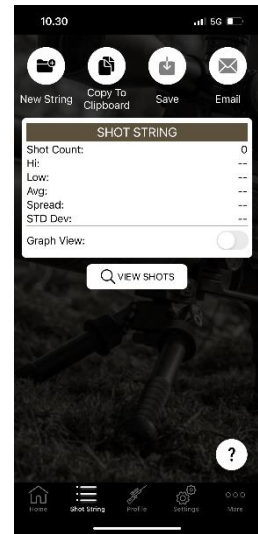

2. At the top of the view, there are options to start a new string, copy the current string to the clipboard, save the string, and email the string.

Saved strings can be accessed in the "More" menu.

3. To view a detailed list of all shots in the string, click "View Shots". If the "Graph View" switch is enabled, the shots will be displayed in a graphical format.
4. To delete individual shots on the "View Shots" view, swipe left on them.

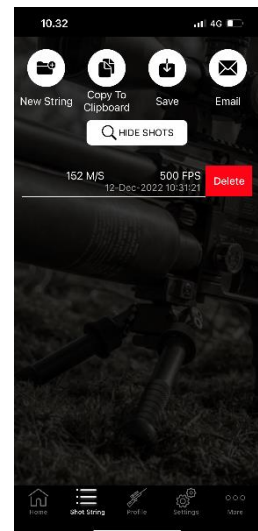

### 5. BALLISTICS

If you have recorded shots with a chronograph that has a drag model, such as G1, selected, a new view will appear on this screen. Under the shot string statistics, you will see a section called "Average Bullet." This section shows the average velocity and ballistic coefficient for the shot string. You can click the "Show" button to view the ballistic solution for the average bullet.

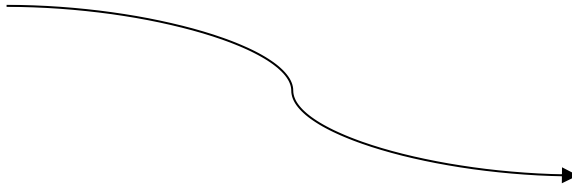
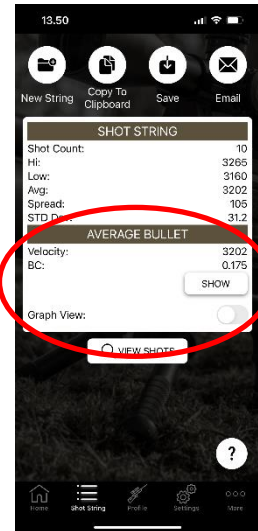
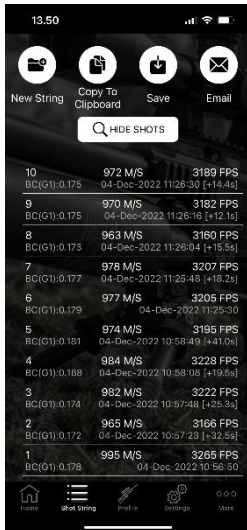

To view the ballistic solution for an individual shot, open the shot view and click on a row.

Please note that the ballistic solution is only available when the BC value is shown for a shot. If the BC value is not shown, make sure that the shots were fired using the appropriate drag model.

A new view will open with settings for the sight-in range and scope angle at the top. For more information on how to use the ballistic solution, see the "Using ballistic solution" section.



## PROFILE PAGE

1. **To select a profile**, go to the profile page and click on the desired profile. You can edit the name of the profile in the settings menu unless it is a default profile. If you set a name for the pellet in the settings menu, this information will be displayed after the profile name. It is recommended to have a separate profile for each type of pellet that you use.

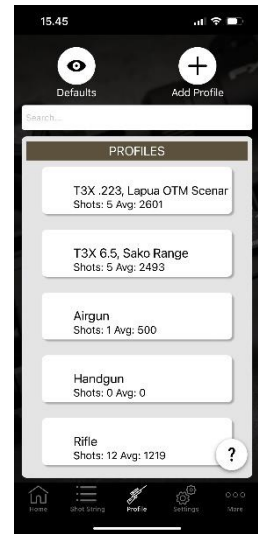

2. To quickly find a profile when the list is long, use the **search bar** in the profile menu. This will allow you to search for the profile by name.

3. **To delete custom profiles**, swipe left on the profile in the profile menu and click "Delete". **To quickly edit** the profile and pellet name or pellet weight, click "Edit".

**To make a copy of a profile**, swipe right.

This can be useful if you want to create a new profile with similar settings to an existing profile, but with some changes.

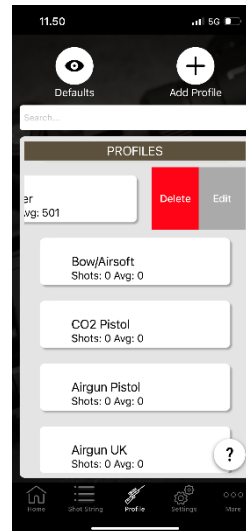

## SETTINGS PAGE

1. The settings menu has a segmented control at the top of the view that allows you to switch between "**Profile Settings**" and "**Application Settings**". The "Application Settings" section contains settings that are applied to all profiles, such as the units of measurement. The "Profile Settings" section contains settings that are specific to the currently selected profile, such as the velocity range.

The **profile name** is located in the "General" section of the settings. You can open the "General" settings section by clicking the "GENERAL" button.

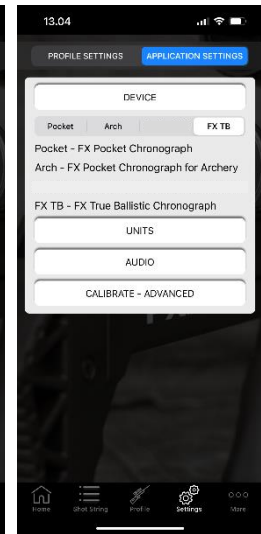
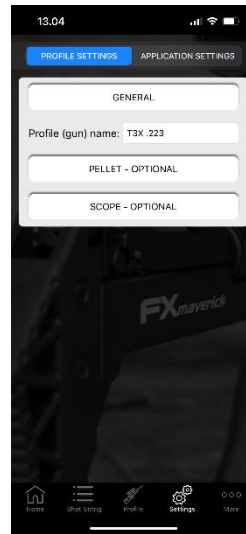

2. The "Pellet" section of the settings is optional. If you choose to enter the make of the pellet, this information will be displayed next to the profile name in the profile list. It is recommended to have a separate profile for each type of pellet that you use.

The **weight of the pellet is important for accurate energy calculations**. Be sure to enter the correct weight for the pellet you are using.

The unit of measurement for pellet weight can be changed from grains to grams in the "Application Settings" section of the settings. This setting applies to all profiles and will affect the unit of measurement used for pellet weight in all profiles.

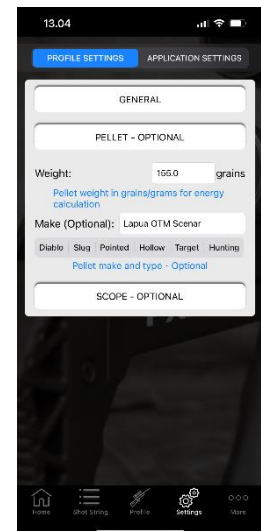

- To define the **scope height for the ballistic calculator**, you can use the "Scope" section. Scope height is the vertical distance between the center of the rifle's bore and the center of the scope. A precision of 1/4<sup>th</sup> inch is generally sufficient for this measurement.

Below the scope height setting, you can find a selection for reticle type. You can choose between MOA (minutes of angle) and Mil Dot reticles.

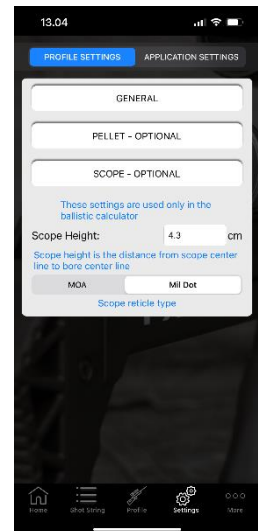

1. In the "**Device**" section of settings, you can choose the option for your device type (e.g. **FX TB** for a FX True Ballistic Chronograph). This setting affects the way the user interface is displayed, and some settings and features may be hidden or shown depending on the device. If you have multiple devices that you want to use with the same profile, you may need to switch between device settings to access all the required settings for that profile. For example, the battery section is only visible when the Pocket (FX Pocket Chronograph) option is selected.

If you accidentally choose the wrong device type and then connect to your chronograph, the app will display a warning and automatically switch to the correct device type.

2. In the "**Units**" section of the settings, you can select the measurement unit for the primary and secondary readings. The weight unit can be set to either grains or grams, and this is used for energy calculations. The distance unit can be set to either yards or meters. These settings apply to all profiles and affect the units of measurement used in all profiles.

3. In the "**Audio**" settings, you can enable voice output for the primary and secondary readings. This will cause the app to speak the readings out loud, allowing you to hear them without having to look at the screen. To activate voice output for the primary or secondary readings, simply toggle the switch next to the corresponding reading.

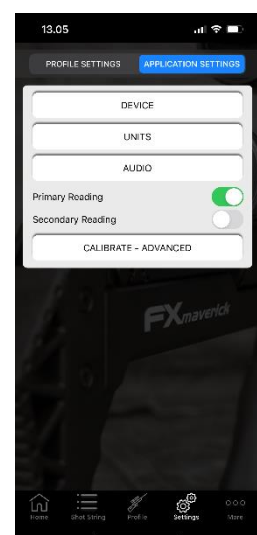
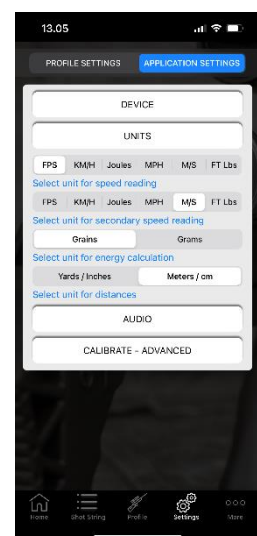
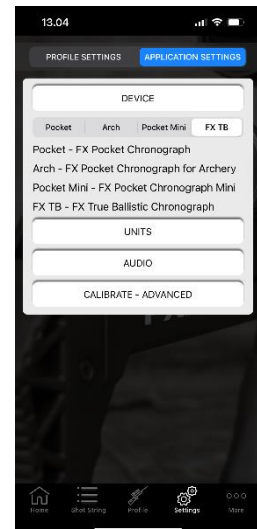



4. In the "**Calibrate**" settings, you can increase or decrease the readings by a certain percentage. This can be useful when you want to match the readings from the chronograph with those from another velocity chronograph. Please note that this does not mean that the unit requires manual calibration. The percentage adjustment is simply a way to fine-tune the readings to match those from another chronograph, if desired.

This feature is available for all device types, but **we strongly advise against using it with the FX True Ballistic Chronograph**. The setting will not only affect the muzzle velocity, but also the ballistic calculations, which may result in incorrect predictions of the bullet trajectory. We recommend not using this feature with the FX True Ballistic Chronograph to avoid inaccurate results.

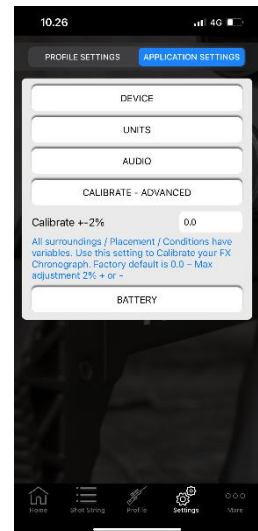

**MORE PAGE**

1. The "More" menu contains links to the support page, manuals, and quick start guides. To access your saved shot strings, click on "Saved Strings" in the "More" menu. This will open a list of all the saved shot strings, where you can view, copy, email, or delete them as needed.
2. The saved shot strings are grouped by month and year in the "Saved Strings" view. To delete a string, swipe left on it as you would in any other table inside the app.

To open a shot string, simply click on the row. This will open a view where you can edit the shot string name and notes, as well as add an image. Clicking on "Add Image" will allow you to add an image of the shot group, for example.

Clicking on "View String" will take you to the next view, where you can see a detailed list of all the shots in the string. From this view, you can also enable the "Graph View" to see the shots in a graphical format. You can also delete individual shots by swiping left on them.

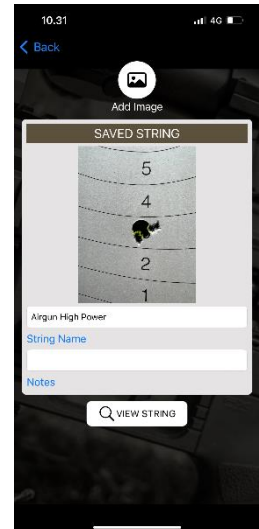

3. The "View String" page has the same options as the "Shot String" page, with one exception. The "View String" page includes a "Copy To Profile" button, which allows you to copy the shots in the saved string to the currently active profile. This will overwrite any existing shots in the active profile.

Other than this, the "View String" page has the same options as the "Shot String" page, including the ability to copy the string to the clipboard, email the string, and view the shots in detail. You can also enable the "Graph View" to see the shots in a graphical format, and delete individual shots by swiping left on them.

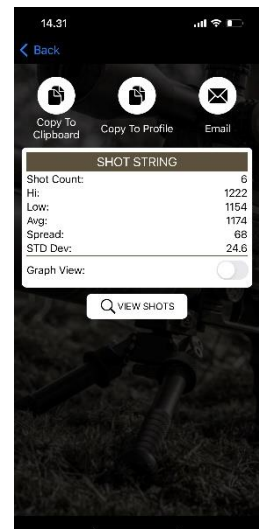

# APP TROUBLESHOOTING

## NOT CONNECTING

### For Android

Begin by closing and reopening the application. Here's how you can do it:

The steps can slightly vary depending on the version of Android, the brand, and the model of the device, but here is a general guide:

1. Tap the square, recent apps, or app overview icon, which is typically at the bottom of the screen. On some devices, you may need to swipe up from the bottom of the screen or tap a dedicated recent apps button.
2. Find the "FX Radar" app in the list of recent apps. You can usually scroll through the list by swiping left or right or up or down, depending on your device.
3. Swipe the "FX Radar" app off the screen to close it. This usually involves swiping up, but on some devices, you might swipe right or left.

#### Accessing device settings:

**For Android 8.0 (Oreo) and newer:** Swipe down from the top of the screen to open the notification shade, and then tap on the gear-shaped Settings icon. Alternatively, open your App Drawer (typically accessed via the button at the center-bottom of the home screen) and locate the 'Settings' app.

**For Android 7.0 (Nougat) and older:** Depending on the specific device and custom skin from the manufacturer, the 'Settings' app can typically be accessed from the App Drawer, or from a shortcut that is often located on one of the home screens.

For Android versions 6.0 (Marshmallow) to 10 (Q), applications using Bluetooth Low Energy (BLE) also require **location permissions to be granted for proper functioning**. This is because BLE can be used to derive your location by looking at what devices are nearby. This is no longer the case starting with Android 11 (R), which separated Bluetooth and Location permissions.

Here's how you can check your Android version and app permissions:

#### Checking Android version

1. **Check your Android version:**
2. **Open your device's main Settings app.**
3. **Scroll down and select About phone or About device.** These options might vary depending on your device.
4. **Scroll down to Android version.** The number listed here should be your Android version.

**If your Android version is between 6.0 (Marshmallow) to 10 (Q):**

1. **Open your device's main Settings app.**
2. **Tap Apps & notifications.**
3. **Tap See all apps or App info.** This will display a list of all applications on your device.
4. **Scroll down and select the "FX Radar".**
5. **Tap Permissions.**
6. **Here, ensure the app has permissions to use Bluetooth and Location.** If a permission is off, tap it, then turn on the switch next to the permission you want to grant.

**If your Android version is 11 (R) or above:**

1. **Open the 'Settings' menu.** You can do this by swiping down from the top of the screen to reveal the notification panel and clicking on the gear icon, or by locating the 'Settings' app in your app drawer and clicking on it.
2. **Tap Apps & notifications.**
3. **Tap See all apps or App info.**
4. **Scroll down and select the "FX Radar".**
5. **Tap Permissions.**
6. **Here, ensure the app has permissions to use Bluetooth.** If a permission is off, tap it, then turn on the switch next to the permission you want to grant.

If you still have issues with the app, please ensure that your device's operating system and the app are both updated to the latest versions, as this can help solve many common problems.

## For iOS

Begin by closing and reopening the application. Here's how you can do it:

1. From the Home screen, swipe up from the bottom of the screen and pause slightly in the middle of the screen. On an iPhone 8 or earlier, double-click the Home button to show your most recently used apps.
2. Swipe right or left to find the "FX Radar" app that you want to close.
3. Swipe up on the app's preview to close the app.

1. **Open the Settings app on your device.**
2. **Scroll down and find the "FX Radar" from the list of apps.**
3. **Tap on the app name to view its permissions.**
4. **Make sure that the Bluetooth permission is toggled on.** If you're using an older version of the app, you might also need to ensure that Location Services is set to "While Using the App" or "Always".

# NO AUDIO

## For Android

If the audio from your "FX Radar" is not playing correctly, you may want to check the volume settings on your Android device. Here's how:

1. **First, ensure that the audio is enabled within the app.** To do this, navigate to the app settings, select 'Application Settings', and then choose 'Audio'. Either the 'Primary' or 'Secondary' audio should be enabled.
2. **Press the volume button on the side of your device.** This will usually be on the right side of the device.
3. A slider should appear on your screen showing the current volume level. If it's too low or completely muted, increase the volume using the volume up button.
4. If you don't see the volume slider or if pressing the volume buttons doesn't affect the app's volume, you'll need to check the settings. Swipe down from the top of your screen to open the notification shade.
5. Look for a gear icon, which represents the Settings menu, and tap on it.
6. Scroll down and select Sound & vibration.
7. Here, you'll see options for different types of volumes including "Media volume", "Call volume", "Ring volume", and "Alarm volume". Slide the button next to "Media volume" to the right to increase the volume.

Remember that "Media volume" controls the volume for music, videos, games, and other media. Make sure that the volume level is high enough to hear sound from the "FX Radar".

## For iOS

If you notice that your device isn't producing any sound, you might want to check the status of this switch. Here's how:

1. **First, ensure that the audio is enabled within the app.** To do this, navigate to the app settings, select 'Application Settings', and then choose 'Audio'. Either the 'Primary' or 'Secondary' audio should be enabled.
2. **Look on the left side of your iOS device, above the volume buttons.** You'll see a small switch.
3. **If the switch is pushed towards the back of the device (showing a red mark), this means your device is in silent mode.** This will mute calls and notifications but doesn't usually affect media and app audio.

4. To turn off silent mode, **flip this switch towards the front of your device** (the screen side). The red mark should no longer be visible.

Please note that the mute switch controls the ringer and alert sounds but doesn't typically mute audio playing from apps or media. However, it's always good to ensure it's not in the silent mode if you're having sound issues.

Once you've turned off silent mode, try adjusting the volume again using the side buttons while the "FX Radar" is open.

1. On the left side of your iOS device, there are two buttons: one for increasing the volume (the one on top), and one for decreasing the volume (the one below).
2. **While you have the "FX Radar" open, press the top button to increase the volume** or the bottom button to decrease the volume. This should adjust the volume of the app directly if you're currently using it.
3. If you press these buttons and the ringer volume indicator appears (it looks like a bell), then your side buttons are currently set to control ringer volume. To change this so that they control your app's volume instead, go to Settings, then Sounds & Haptics, and then turn off the switch next to "Change with Buttons" under the "Ringer and Alerts" section.

Now, when you press the volume buttons while using an app, they should control the app's volume instead of the ringer volume. Remember, the physical buttons will control the volume of sounds and music when apps are in use, but they will control the ringer volume when no apps are actively used or during the lock screen state.

**Federal Communication Commission Interference Statement**

This equipment has been tested and found to comply with the limits for a Class B digital device, pursuant to Part 15 of the FCC Rules. These limits are designed to provide reasonable protection against harmful interference in a residential installation. This equipment generates, uses and can radiate radio frequency energy and, if not installed and used in accordance with the instructions, may cause harmful interference to radio communications. However, there is no guarantee that interference will not occur in a particular installation. If this equipment does cause harmful interference to radio or television reception, which can be determined by turning the equipment off and on, the user is encouraged to try to correct the interference by one of the following measures:

- Reorient or relocate the receiving antenna.
- Increase the separation between the equipment and receiver.
- Connect the equipment into an outlet on a circuit different from that to which the receiver is connected.
- Consult the dealer or an experienced radio/TV technician for help.

FCC Caution: Any changes or modifications not expressly approved by the party responsible for compliance could void the user's authority to operate this equipment.

This device complies with Part 15 of the FCC Rules. Operation is subject to the following two conditions: (1) This device may not cause harmful interference, and (2) this device must accept any interference received, including interference that may cause undesired operation.

**IMPORTANT NOTE:****FCC Radiation Exposure Statement:**

This equipment complies with FCC radiation exposure limits set forth for an uncontrolled environment. This equipment should be installed and operated with minimum distance 20cm between the radiator & your body.